

BLACK FRIDAY

-50%

art3f.
international contemporary art fair

Gallery
ART FAIR

50%*

DISCOUNT ON ALL CONTRACTS

**Take advantage now
before prices increase on January 1, 2025.**

Dear Exhibitor,

Following numerous requests, although the Black Friday offer was supposed to end on 11/30/2024, **we have exceptionally agreed to extend it.**

As all good things must come to an end, **we are obliged to set a date.**

It has therefore been decided to end the Black Friday -50% offer **on Sunday, December 22, 2024, at midnight.**

We hope you will appreciate this gesture.

In return, unfortunately, and to offset the significant increases we experienced in 2023 and 2024 (exhibition venues, heating, transport, fabric, subcontractors, etc.), **we will not be able to offer this discount in 2025.**

Additionally, we remind you of the implementation of our **new pricing starting on 01/01/2025.**

- ✓ **Prepare for 2025 and choose the best locations !**
- ✓ Offer **subject to availability of stands allocated to this offer**
- ✓ Offer valid **for all fairs in 2025**
- ✓ Possibility **to choose one or more dates**

* Offer valid until December 22, 2024, at midnight, subject to availability of stands allocated to this offer and cannot be combined with other offers already in progress (Discovery Offer, Pack Offers, Member Offer, etc.). Payment in full on receipt of invoice.

BLACK FRIDAY 50% BLACK FRIDAY 50%

BLACK FRIDAY

-50%

2025

ZURICH (Switzerland)

17>19 january 2025

PARIS

24>26 january 2025

BORDEAUX

31 jan.>02 february 2025

TOULOUSE

07>09 february 2025

STRASBOURG

28 feb.>02 march 2025

NANTES

07>09 march 2025

LYON

14>16 march 2025

LUXEMBOURG ART FAIR (Luxembourg)

RESERVED FOR GALLERIES ONLY

27>30 march 2025

MILAN (Italy)

04>06 april 2025

BARCELONA (Spain)

11>13 april 2025

REIMS

25>27 april 2025

KORTRIJK (Belgium)

16>18 may 2025

DORTMUND (Germany)

23>25 may 2025

MONACO

19>21 september 2025

PARIS

26>28 september 2025

LUXEMBOURG (Luxembourg)

03>05 october 2025

HAUTE-SAVOIE

10>12 october 2025

LAUSANNE ART FAIR (Switzerland)

RESERVED FOR GALLERIES ONLY

30 oct.>02 november 2025

MULHOUSE

14>16 november 2025

BRUSSELS (Belgium)

21>23 november 2025

MARSEILLE

28>30 november 2025

BORDEAUX

05>07 december 2025

* Offer valid until December 22, 2024, at midnight, subject to availability of stands allocated to this offer and cannot be combined with other offers already in progress (Discovery Offer, Pack Offers, Member Offer, etc.). Payment in full on receipt of invoice. (1) Reserved for galleries only.

BLACK FRIDAY 50% BLACK FRIDAY 50%



EXHIBITOR PARTICIPATION CONTRACT

This registration file is submitted to the art3f selection committee. This artistic committee is responsible for ensuring the global quality of the works presented and the prestige of the event. The artistic committee's remit is not to produce art works but to ensure the credibility of the event through its choices. For this reason, the committee will not enter into correspondence to justify refusals.

Caution : Sub-location rentals to artists is strictly prohibited.

9th EDITION
art3f. 
International contemporary art fair
TOULOUSE

PAINTER SCULPTOR CERAMIST PHOTOGRAPH

07>09 February 2025
Parc des Expositions
MEETT

Friday 4pm-11pm
Saturday 10am-8pm
Sunday 10am-7pm

SUBMITTING YOUR FOLDER

By email to :
info@art3f.com

By postal mail to :
art3f
BP2271
68068 Mulhouse Cedex
France

For artists :
A CV, a biography, your artistic journey, latest exhibitions, 5 photos of works stating your name, the title of the work and the format.

For gallery owners :
An information sheet on your gallery, latest exhibitions, 1 photo of a work for each artist represented.

Once your application has been approved and accepted by the artistic committee, the total amount shall be settled **at reception of the invoice.**

ARTIST

Name : First name :

Artist name :

Address :

Post code : Town :

Country : Telephone :

Mobilephone : Email :

Website :

Compulsory information :

Maison des artistes, affiliation n° : SIRET :

VAT-number :

GALLERY OWNER

Name of the gallery :

Name, First name of manager :

Address :

Post code : Town :

Country : Telephone :

Mobile phone : Email :

Website :

Compulsory information :

Registration n° : VAT-number :

Number of artists represented on the stand :

Name of artists	Their artistic discipline(s)
.....
.....
.....
.....
.....
.....
.....
.....
.....
.....
.....



YOUR STAND

The price per sqm comprises wooden partitions covered with brushed white cotton, 1 x 300w spotlight for 3sqm.

Warning ! To avoid errors, please complete all the form's fields.
If you want an electric box for your personal use (card machine, laptop, phone...), please tick the «electric box» option.

TOULOUSE

A. THE STRUCTURE

Price per sqm excluding tax : € 170	
Stand of sqm x € 170 (minimum 9 for an artist, 18 for a gallery) €
Corner: 300 € per corner x (1, 2, 3 ou 4 corners) €
<input type="checkbox"/> closed <input type="checkbox"/> open	
Total A € excl tax

B. COMPULSORY FEES

Badges (2 for an artist, 4 for a gallery) 1 catalog, One full-colour page in our catalog, Invitations for 2 people, Insurance (legal liability).	
Total B	400 € excl tax

C. ADDITIONAL OPTIONS

Brushed cotton : <input type="checkbox"/> white for free or <input type="checkbox"/> black €150 or <input type="checkbox"/> grey €150 €
Partition 1m : € 95 excl. tax x €
Single laminated cupboard door, white : € 290 excl. tax x €
Curtain 1m wide : € 60 excl. tax x €
Extra 300w spotlight : € 60 excl. tax x €
Mesh 15€ the ml (to fix spots out of partitions) + post 40€ (according to config.)	Consult us
Electric box 1KW : € 190 €
Brushed cotton roof lining per sqm : € 25 excl. tax x €
Additional page in the catalog : € 190 x €
Additional badge : € 30 x €
Total C € excl tax

SUMMARY OF YOUR ORDER

Total = Total A + Total B (€ 400) + Total C € excl tax
VAT (20%) €
Total incl tax € incl tax

YOUR DESIRED STAND PLAN

— = 1meter

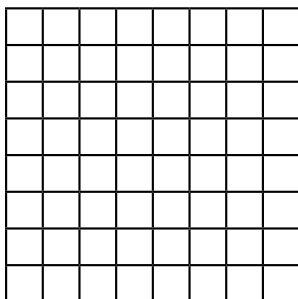

- RATE VALID ONLY IF CONTRACT IS RETURNED SIGNED AND COMPLETED
- FOLDS PROCESSED IN THE ORDER OF ARRIVAL
- WITHIN THE LIMITS OF THE AVAILABLE STANDS ALLOCATED TO THE OFFER
- ANY OPTION ADDED SUBSEQUENTLY WILL BE INVOICED AT THE NORMAL RATE
- PAYMENT IN FULL ON RECEIPT OF INVOICE

BLACK SUMMER DISCOUNT

50%

(Total x 0,5)

..... € incl tax



TOULOUSE

PAYMENT METHOD

By check made out to art3f By credit card (by phone).

Bank transfer

Code Banque	Code guichet	Numéro de compte	Clé RIB	Domiciliation
30087	33220	00020864001	88	CIC MULHOUSE SINNE

IBAN : FR76 3008 7332 2000 0208 6400 188

BIC / SWIFT : CMCIFRPP

VAT must be paid by foreign exhibitors who may apply for a refund.

From 1/1/2010, EU companies can not enter claims on paper anymore. If you want to enter a claim for VAT refund now, you need to enter a claim electronically using the online portal, put at your service, by the competent administration of your member state of establishment. The administration of your member state of establishment will then forward it, by electronics means, to the member state of refund, for further handling. If you need more information on this subject, please look for info on the website of your national tax administration, or contact them.

More info can be found as well on the website of European commission.

https://taxation-customs.ec.europa.eu/index_en

DATES AND SCHEDULES

07-08-09 February 2025
Parc des Expositions - MEETT
Concorde Avenue
31840 AUSSONNE

Friday : 4pm-11pm
Saturday : 10am-8pm
Sunday : 10am-7pm

BOOTH BUILDING

Thursday from 8pm
Friday from 9am
dismantling on Sunday from 7pm

INFORMATIONS

art3f will be held in Parc Expo and the applicable regulations are therefore the federation rules applying to fairs and exhibitions.

The rented stand is occupied by the contractor(s) from the beginning of the event till the end, within the opening hours. **You undertake to not dismantle the booth before the visitors leave.**

In agreement with the fair commissioner, you will endeavour to decorate and present your stand in a way that honors the prestige of the event and you will take care not to damage the partitions and materials made available to you.

I have read the fair regulations below and agree to respect them without reservations.
The total amount shall be settled at reception of the invoice.

Name:
Date:
Signature and stamp:

Completed folder to be sent to:
art3f
BP2271
68068 Mulhouse Cedex - France
Registration folders will not be returned, even in the event of a refusal.
For more information, call art3f on :
+33 (0)3 89 59 02 40 or contact by email :
info@art3f.com



EXAMPLES OF STANDS

Here are some ideas of modules, options and structure of stands. Those are just examples, do not hesitate to draw your stand according to your wishes by using the grid in page 2. Respect nevertheless a minimal depth of 3 meters. Possible surfaces (multiples of 3): 9, 12, 15, 18, 21, 24, 27sqm, etc.

TOULOUSE

- partitions
- exhibition spaces
- ↑ spotlight

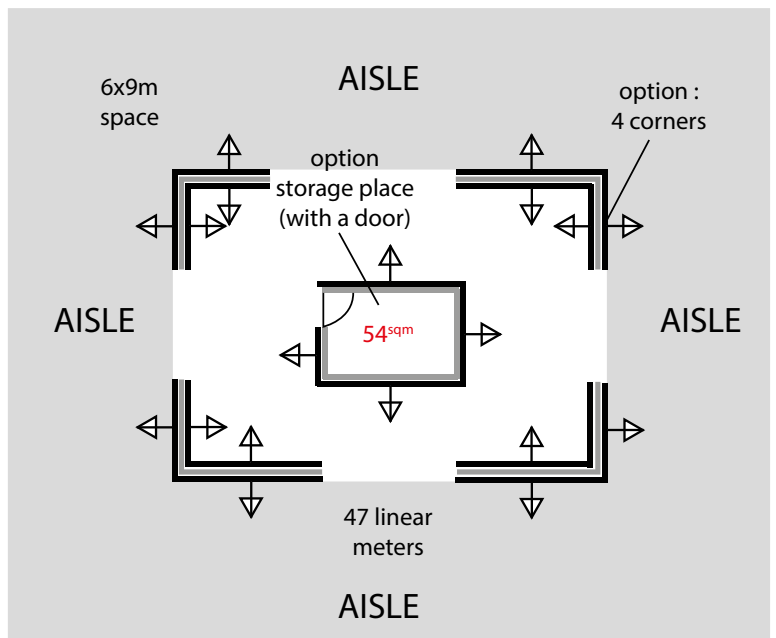
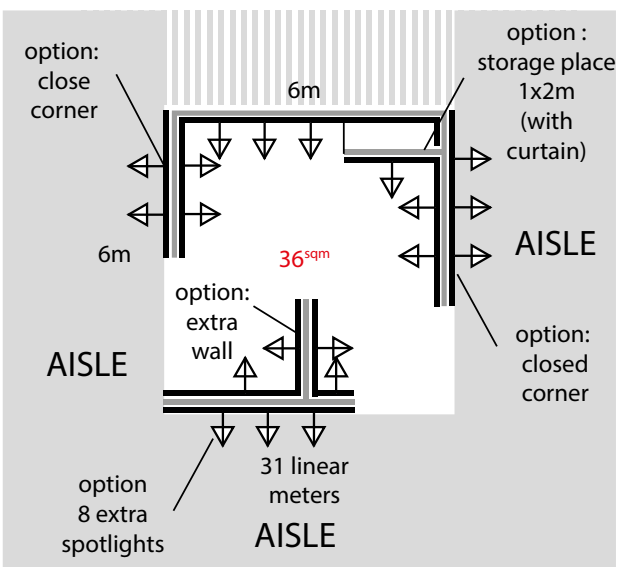
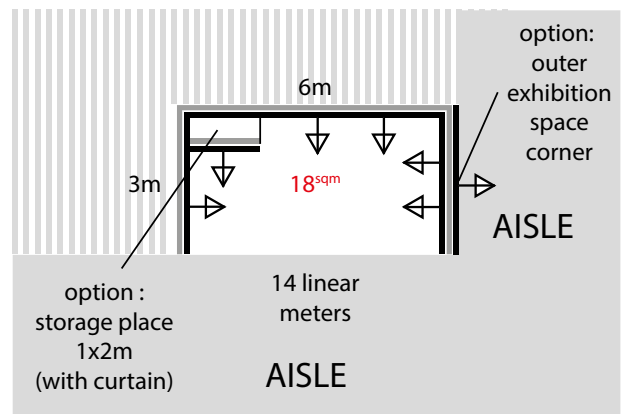
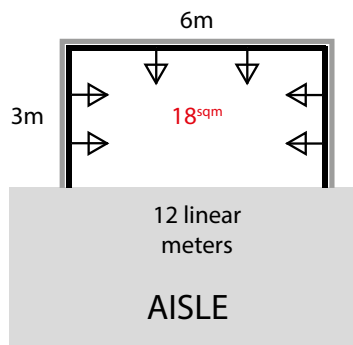
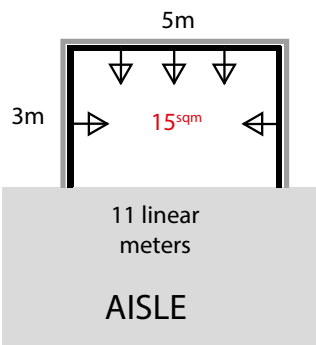
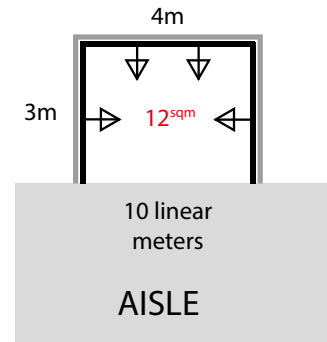
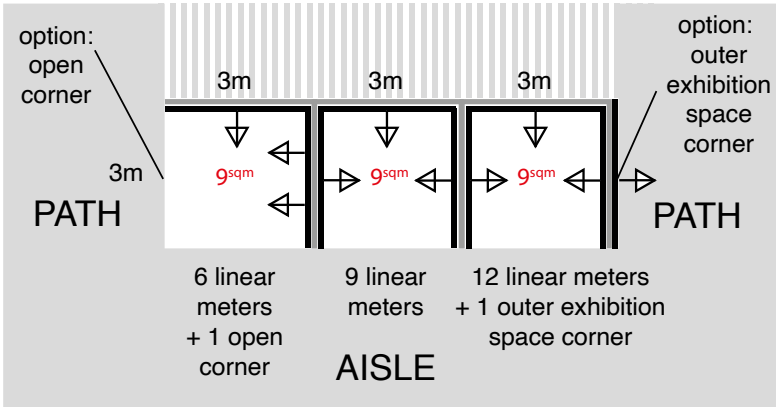

I. GENERAL PRESENTATION**Art. 1. Object of the show**

ART3F (the «Organizer») is organising a contemporary art fair (the «Salon») named after **art3f Toulouse** will be held from 07 to 09 February 2025 with a vernissage on Friday from 6pm to 11pm. art3f will be open for general attendance Friday from 4pm, Saturday and Sunday from 10am.

Any questions relating to the show (conditions of participation, progress, etc.) should be addressed to the Organizer (at the address listed at the top of this document).

Art. 2. Scope - contract documents

These General Terms and Regulations are enforceable against any exhibitor and candidate exhibitor. They are supplemented by the provisions in the exhibitors' application.

The transmission of the application for participation is worth accepting of these General Conditions and Internal Regulations. These General Terms and Regulations may, if necessary, be supplemented by any conditions put in place by the owner of the venue where the show is held.

Art. 3. General provisions

These General Terms apply as of right to the provision of a stand and the sale of works of art, art objects, as part of the show. The Organizer expressly reserves the right to unilaterally change these conditions at any time if circumstances require it and/or in the interest of the Show. In this case, these changes will be specified in a written document provided to exhibitors and will apply immediately and as of right. In the event of a breach of a stipulation of these terms and general conditions, all other stipulations will retain their full strength and scope.

In addition, the purpose of this regulation is also to define the rules for the admission and participation of exhibitors at ART3F show.

Candidate artists and contemporary art galleries receive a participation contract. They may be eligible to participate depending on the program they offer and subject to an available location for that program. Exhibitors agree to respect, without any restriction or restraint, the terms of this regulation and any new provisions that could be imposed by the circumstances and adopted by art3f in the interest of the fair.

Art. 4. Exhibitors

Exhibitors are the artists and professional galleries that officiate in the fields of painting, sculpture, photography, artistic glass, ceramics, publishers of art books, prints, lithographs, in the accepted definitions of original works, the media, the registry of commerce validating the activity. Exhibitors, French or foreign, who have selected a stand will have to respect the nomenclature of the elements allowed to be exhibited by the organizer.

II. TERMS OF PARTICIPATION - FINANCIAL CONDITIONS**Art. 5. Selection**

The applicant is asked to attach a complete file to the participation contract. Only artists nominated in the admissions file and who have been accepted by the selection committee will be able to be exhibited on the stand.

For artists : a Curriculum Vitae (resume), a biography, your artistic career, your latest exhibitions, 5 photos of works indicating your name, the title of the work and the format.

For gallery owners : an information sheet on your gallery, 1 photo of artwork per artist represented.

The Organizing Committee may accept or refuse the exhibitor without relying on a reason. Participation in one or more editions of art3f does not result in automatic admission for the following year.

Art. 6. Booking and settlement

Offer valid until December 22, 2024, at midnight. Once your application has been validated and accepted by the artistic committee, **full payment must be made upon receipt of the invoice.**

The exhibitor will be admitted to the fair after paying the

full fee due, and will then be able to take possession of the stand reserved for him.

In case of non-compliance with payment deadlines, any discounts will be cancelled and the entire invoice will be due. Parking fees may be applied depending on the location of the exhibition.

Art. 7. Non-acceptance

If your file is not accepted by the art committee, your registration file and attachments will not be returned to you. The organizer will proceed with the destruction of the data received from an unsuccessful exhibitor.

Art. 8. Cancellation

The balance of the rental amount is due after the application is accepted by the artistic committee. In the event of the exhibitor's withdrawal of membership, the exhibitor will remain liable for the entire location bill.

III. MATERIAL CONDITIONS**Art. 9. Allocation of stands**

The Organizer sets out the plan for the show. It distributes the stands taking into account, as far as possible, the wishes expressed by the exhibitors, the nature of the products and services they showcase, the planned layout of the stands and, if necessary, the date of acceptance of the orders.

The location of the stand assigned to an exhibitor is communicated to the exhibitor purely as an indication by means of a plan. It is up to the exhibitor to ensure that the plan is compliant before the installation of his stand, as the responsibility of the Organizer cannot be engaged in this regard.

Any complaint about the location of a booth must be notified in writing to the Organizer within eight days. After this time, no claims will be taken into account.

The Organizer expressly reserves the right to unilaterally change the surface area of a requested or allocated stand within 3% area up or down, as well as the layout of the corresponding areas, without change of price.

Art. 10. Occupying the site

The locations will be available for their set up by exhibitors from 9am Friday to Sunday at midnight.

Any unoccupied location on Friday by 1 p.m. may be assigned by the organizer to another exhibitor.

The exhibitor who was first attributed the site will not be entitled to compensation. Works arriving after the opening of the event may only be sent to the stands outside of open hours to the public. Locations after the demonstration must be vacated at midnight on Sunday. In case an exhibitor has not removed his goods within the allotted time, the organizer, for the security of the goods, to put those in custody at the fair's authorized carrier, at the expense of the exhibitor. Any additional damage and costs that may occur during this safety will not be the responsibility of the organizer. Each booth must be permanently occupied during the opening hours of the fair, last day included. Exhibitors must leave the sites, sets and equipment that were made available to them, in the state in which they received them.

Art. 11. Site layout

The layout of the stands is carried out according to the general plan drawn up by the Organizer. Any special arrangements must be authorized beforehand and in writing by the Organizer and must be carried out in strict compliance with the requirements of the technical file. Notwithstanding the above, the Organizer expressly reserves itself the right to request alterations or removals of developments that would negatively affect the general appearance of the Show or affect public traffic which would hinder neighbouring exhibitors; same for alterations or removals of developments that do not comply with the plan and model that has previously been submitted to the Organizer; all of this at the exclusive expenses of the exhibitor concerned. The specific decoration of the stands is carried out by the exhibitors under their exclusive responsibility. It must comply with the safety regulations issued by the public authorities as well as the general decoration plan and signage set out by the Organizer. The use of any sound, light or audiovisual process is prohibited, unless prior and written permission from the Organizer. Finally, the Organizer reserves the right to position an electric box (of varying

size and color) in your booth to power the lighting system and move the stand.

Art. 12. Cleaning

Cleaning and permanent maintenance of the floors (traffic, entrance and available areas on the floors) will be taken care of by the care of and be at the expense of the organizer. The exhibitor is responsible for the daily cleaning of his booth. Waste will have to be deposited in the aisles when the Showroom doors are closed - cleaning takes place at night.

Art. 13. Disassembly

The stand will have to be disassembled on Sunday evening from 7pm and released at midnight.

The partitions must be rendered without any support and hanging materials (screws). In case of non-compliance, you will be charged a minimum of 50 euros per partition by a cleaning crew.

IV. MISCELLANEOUS**Art. 14. Sales**

Sales are allowed during the event. However, for security reasons, no one is allowed to leave the hall of the fair with merchandise without an exit voucher describing the goods carried out, this voucher has to be signed by the exhibitor and acknowledged by the organizer.

Mandatory price display.

Mandatory display, in a visible way, on a panel in A3 format and in a character size that cannot be less than size 90, the following sentence: «The consumer does not have a right of retraction for any purchase made on this stand»

Cases of original works of art and objects of antiquity value:

According to Articles 4 and 5 of the December 3, 1987 Decree about the rights of buyers to Price Information and in accordance with the July 19, 1988 letter of application enforcing the provisions of the December 3, 1987 Decree, which provides accommodations for works of art: «Responding to the specifics of these products, it may be permissible to put a discreet label on items exposed to public view or, in art galleries, to consult a list of prices.»

Art.15. Security

All necessary measures will be taken by the organizer to ensure that the guarding of the fair outside the opening hours is effective. It is up to each exhibitor to exercise vigilant control over their own equipment or possessions during public hours, and during the assembly and dismantling of the stands. Exhibitors will be required to allow free access to electrical boxes located on or near their location.

Art. 16. Miscellaneous prohibitions

Unless expressly authorized by the organizer, exhibitors are prohibited:

- to rent all or part of their location free of charge, for payment or exchange of service
- to broadcast music in their booth or to use machines that could annoy other exhibitors.

V. INSURANCE**Art. 17. Insurance**

Apart from covering the risks of mandatory insurance, exhibitors must make sure with their usual company that they are covered for all other risks incurred, in particular theft, degradation of works or exhibition materials. Exhibitors absolve the organizers of any responsibility in the event of fire, explosion, flood, various disturbances, and for any element not attributable to the organizers, agents and attendants. In particular, the organizers cannot be asked for damages in the event that the rented package cannot be effectively used by exhibitors as a result of events of force majeure.

VI. CANCELLATION OF THE SHOW, POSTPONEMENT OF DATES, LIABILITY, TERMINATION**Art. 18. Cancellation of the show or postponement of dates**

In the event of cancellation of the show for reasons beyond the Organizer's control, accepted orders will be maintained as of right and without formalities, excluding any compensation. In the event of cancellation of the show or date lag, for reasons beyond the organizer's control, exhibitors will not be entitled to any refund or compensation.

Art. 19. Limitation of liability

Each exhibitor is solely responsible for complying with the regulations applicable to his activity to the works and objects of art he sells (particularly in relation to all required customs formalities), for his commercial offers, as well as for the accuracy of any information transmitted to the Organizer, especially for the needs of the show's communication material.

It therefore guarantees the Organizer against the consequences of any appeals or claims in this respect. The Organizer's proven liability is expressly limited to the repair of direct property damage, exclusive of any intangible and/or indirect damage, such as, in particular and without limitation, loss of turnover, operating loss, commercial or image damage, etc., subject to any mandatory legal or regulatory provision. In addition, and in all cases where the law permits such a limitation, the overall responsibility of the Organizer in connection with the provision of a stand and/or the sale of communication tools is expressly limited to the sums actually paid by the exhibitor in that capacity.

Art. 20. Termination

Any failure by the exhibitor to comply with any of his obligations under these terms and/or orders and/or registration file will, as of right and without prior notice, result in the immediate termination of the services ordered and the exclusion of the exhibitor from the show. In this case, the exhibitor will not be entitled to any refund and will be liable as a matter of law to the Organizer for compensation equal to 25% of the price of the stand made available to him, as a criminal clause, notwithstanding the allocation of the so-called stand to another exhibitor.

Art. 21. Responsibility of the organisers

1. As the availability of the exhibition centres may change according to their calendar, this date may be changed, although this is exceptional and will not lead to cancellation of the contract or payment of compensation.
2. Furthermore, in case of force majeure (transportation strike, viruses, epidemics, pandemics, natural disasters...) the organizers can postpone the fair, change its opening hours, exclude the public. They can cancel or close it before the scheduled date. In all cases, contracts with exhibitors remain valid and payment for booth rentals and other services is due. In addition, the organizer is free of reimbursement of any ancillary expenses (hotel, transport, etc.).

VII. APPLICABLE LAW, ATTRIBUTION OF JURISDICTION**Art. 22. Claims**

Exhibitors' claims must be submitted, for the purpose of an amicable settlement, to the organizer by registered letter with acknowledgement of receipt within 15 days of the closing of the fair. After this period, claims will no longer be admissible. Any dispute will fall exclusively within the jurisdiction of the Mulhouse courts and will be subject to French law. For the interpretation of the regulation, only French text is authoritative.